

Citizens Sensing Toolkit

Citizens Science Vlaanderen

Gijs Boerwinkel - gijs@waag.org

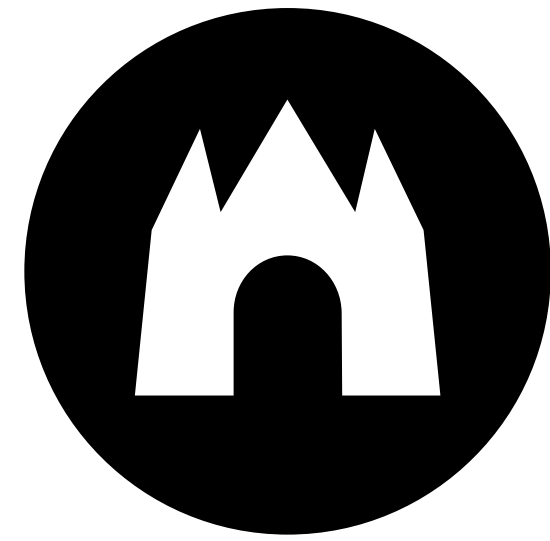

waag
technology & society



waag



open-
-fair
inclu-
-sive

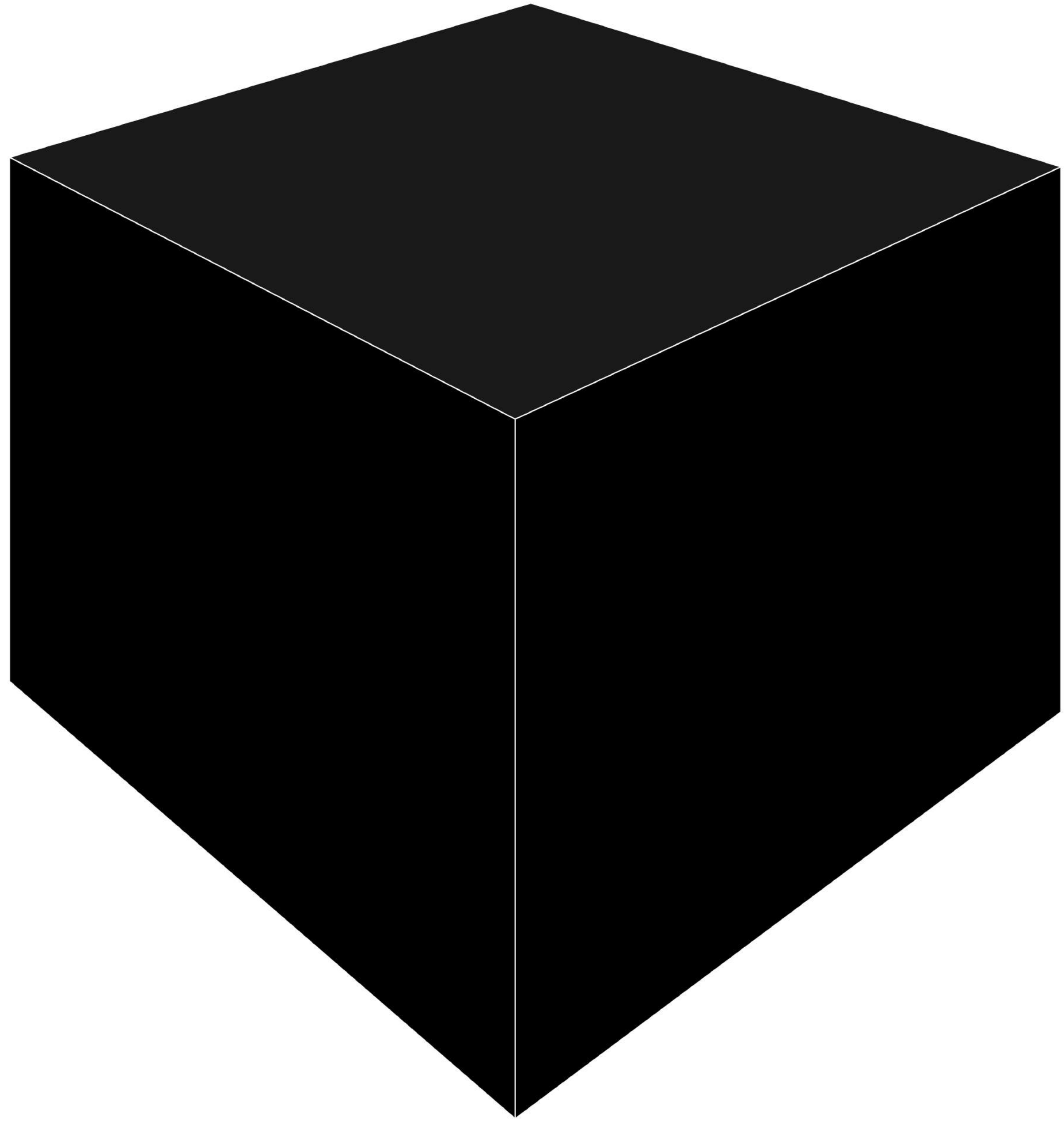

OWN YOUR OWN

IF YOU CAN'T

OPEN IT,

YOU DON'T OWN IT



**SMART
CITY**



Door initiatief weg te nemen, top-down controle op te leggen en te focussen op het maximaliseren van efficiëntie in plaats van de mogelijkheid, is de 'smart city' een ramp die nog moet gebeuren.

Onze hoop ligt bij de burger:
de smart citizens.

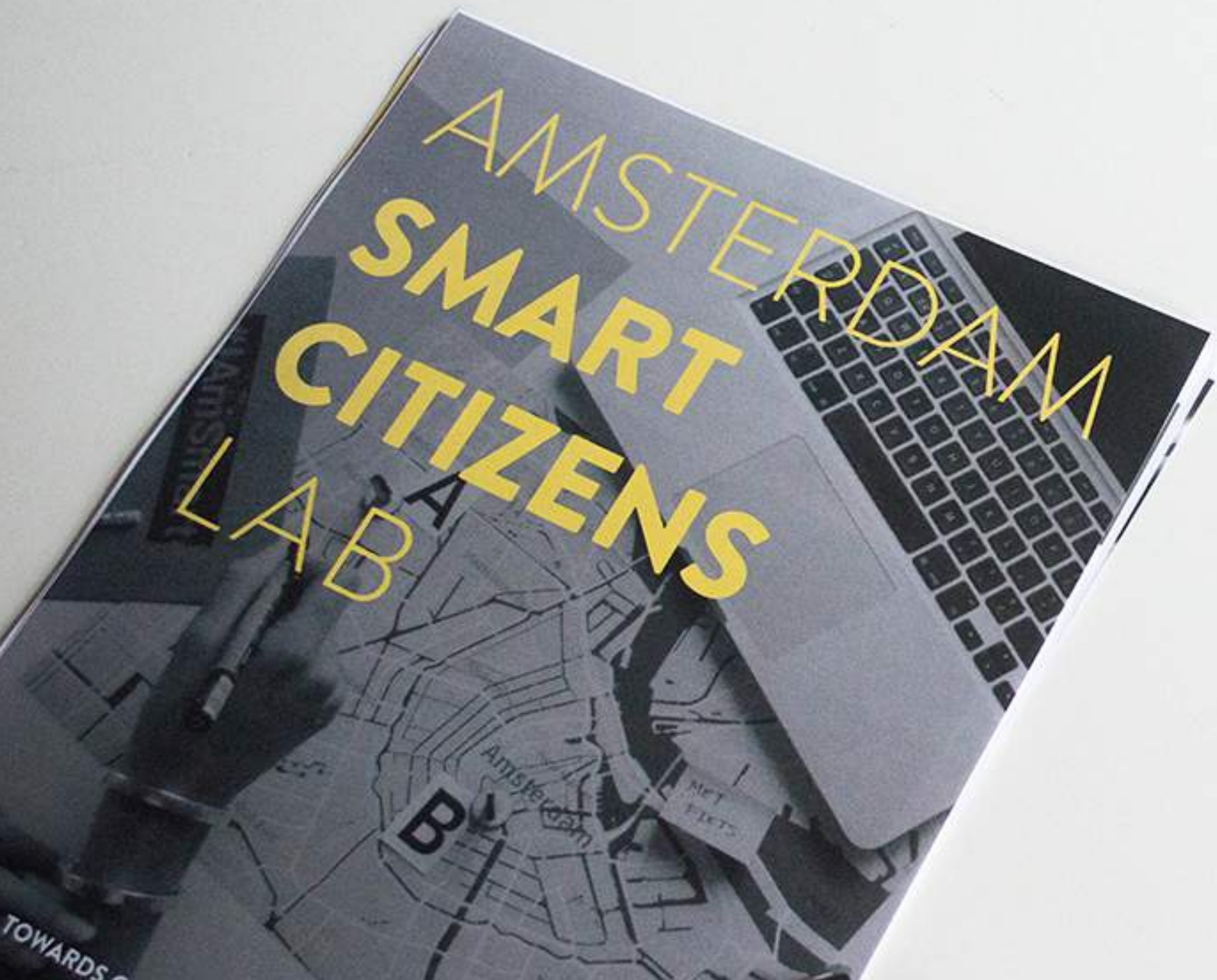

AMSTERDAM
SMART
CITIZENS
LAB

TOWARDS

AMSTERDAM
**SMART
CITIZENS
LAB**

crash course #1

AIR QUALITY



AMSTERDAM
**SMART
CITIZENS
LAB**

crash course #2

NOISE POLLUTION



AMSTERDAM
**SMART
CITIZENS
LAB**

crash course #3

WATER QUALITY





Making
Sense





SENSING

Open source technologies that gather environmental data



AWARENESS

Enabling and designing platforms for collective sensemaking



ACTION

Moving on a trajectory from awareness to positive change

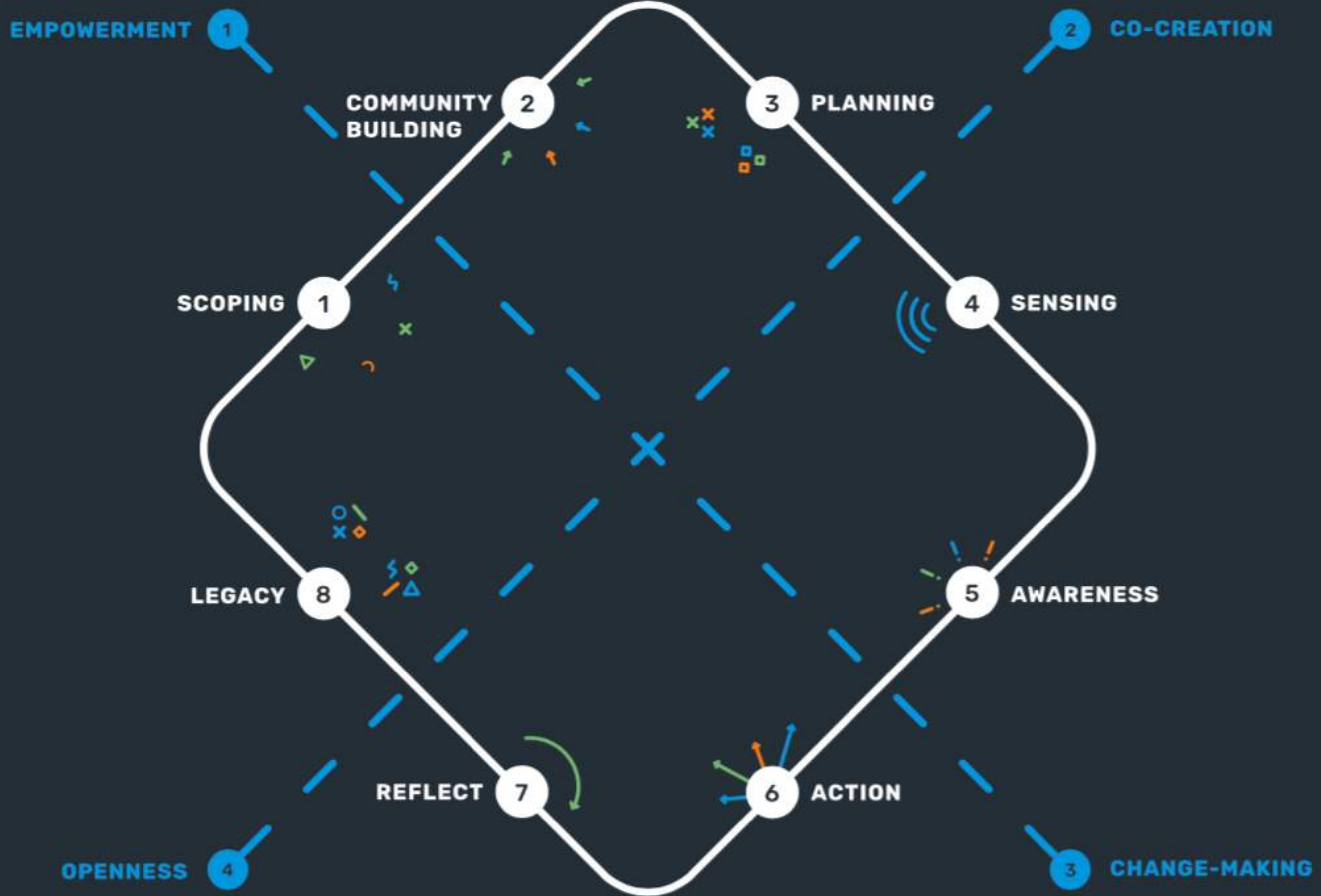

we code for smart citizens

1. Scoping



Scoping:

- Wees geen oplossing opzoek naar een probleem
- Definieer problemen samen met burgers
- Kijk lokaal, ontwerp lokaal



Wijk aan Zee vs. Tata Steel: in gevecht met een 'ontembaar monster'

Het waait niet meer over, die zwarte regen, zeggen de inwoners van Wijk aan Zee. Ze vechten tegen twee 'Goliaths': Tata Steel en de overheid.

Tom Kreling en John Schoorl 14 januari 2019, 9:00

deVolkskrant



Tata Steel zegt sorry voor hinder van aanhoudende stofwolken

Wijk aan Zeeërs eisen van de provincie een plan van aanpak voor de overlast van Tata Steel en Harsco



Tata Steel IJmuiden

Druk op Tata Steel neemt toe: boete milieudelicten verhoogd van 5.000 naar 25.000 per overtreding

24-01-2019, 11:36



VELSEN NOORD Staalgigant Tata Steel ligt onder het vergrootglas. Het bedrijf kan zich geen nieuwe milieu-incidenten meer veroorloven. Spreekwoordelijk dan. Het maxi-

we code for smart citizens

2. Community Building



Community building:

- Creëer ruimte voor dialoog
- Breng verschillende stakeholders samen
- Gebruik bestaande infrastructuren
- Ga waar de community is
- Technologie (sensor) als tool
- Wees duidelijk vooraf over doelstellingen (co creëer je doelstellingen)



we code for smart citizens

3. Planning





Planning

- Zet de vragen van burger centraal
- Co creëer je meetstrategie
- Maak het zo snel mogelijk visueel
- Denk aan community building in je planning
- Communiceer over je planning

we code for smart citizens

4. Sensing



Sensing

Technologie:

- Ontwikkel/gebruik open-source technologie
- Documenteer je technologie
- Maak duidelijke instructables
- Check Github van Waag

github.com/waagsociety

HOLU

Air Quality Sensor Kit
BASIC/EXTENDED

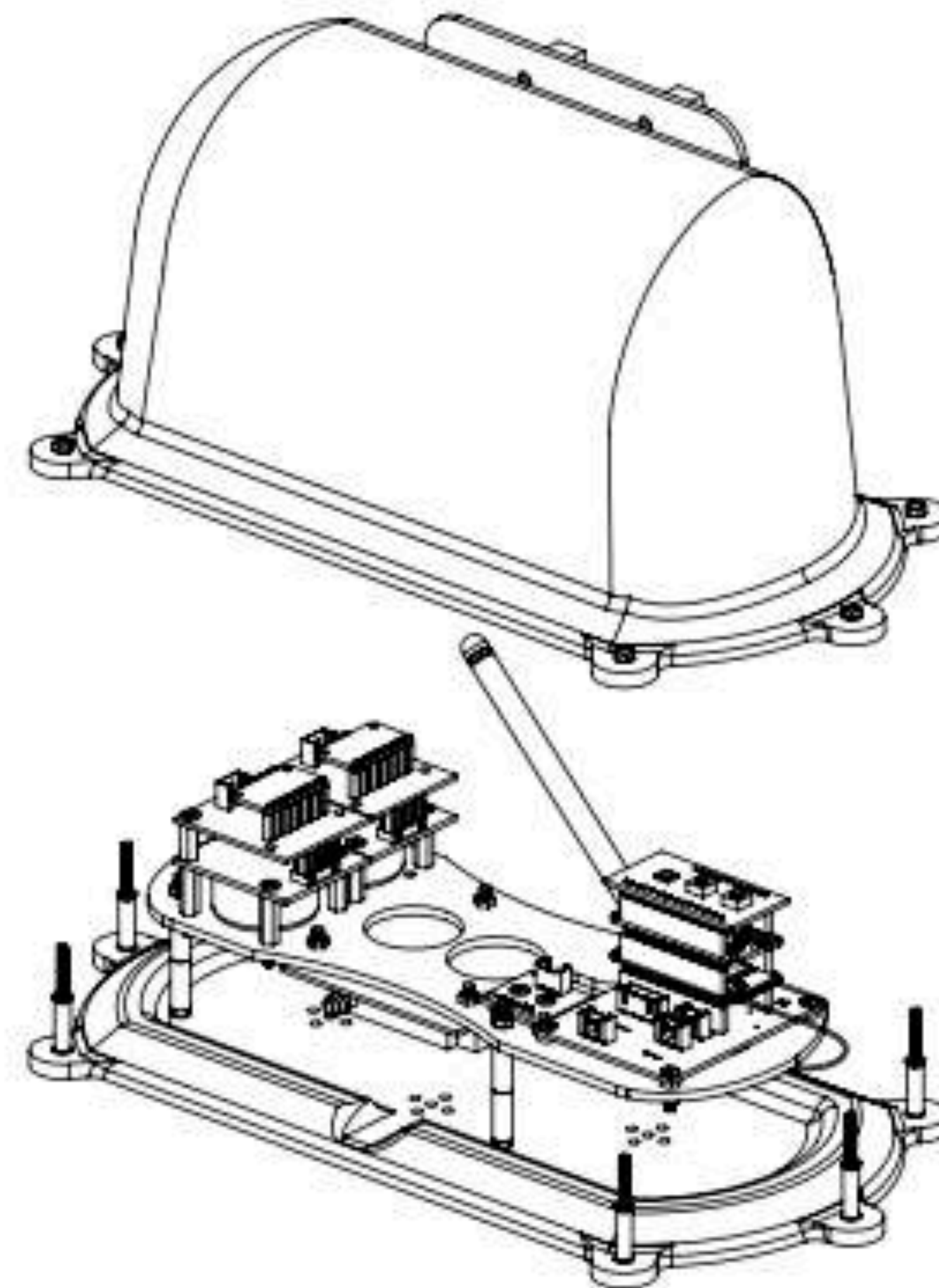

Basis sensor kit - PM 2.5

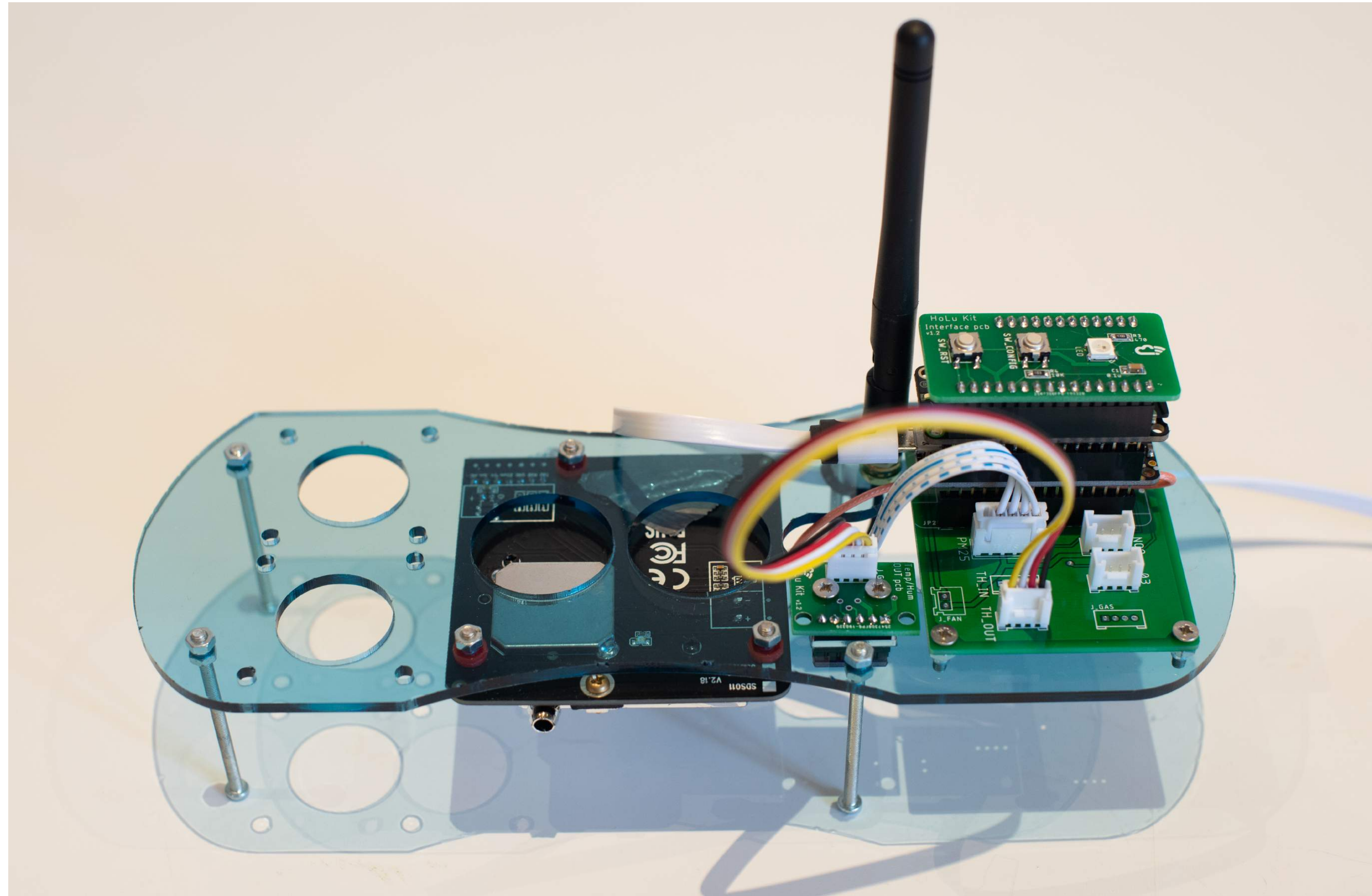

- PM2.5
- Luchtvochtigheid
- Temperatuur

Uitgebreide sensor kit - PM2.5, NO2 & O3

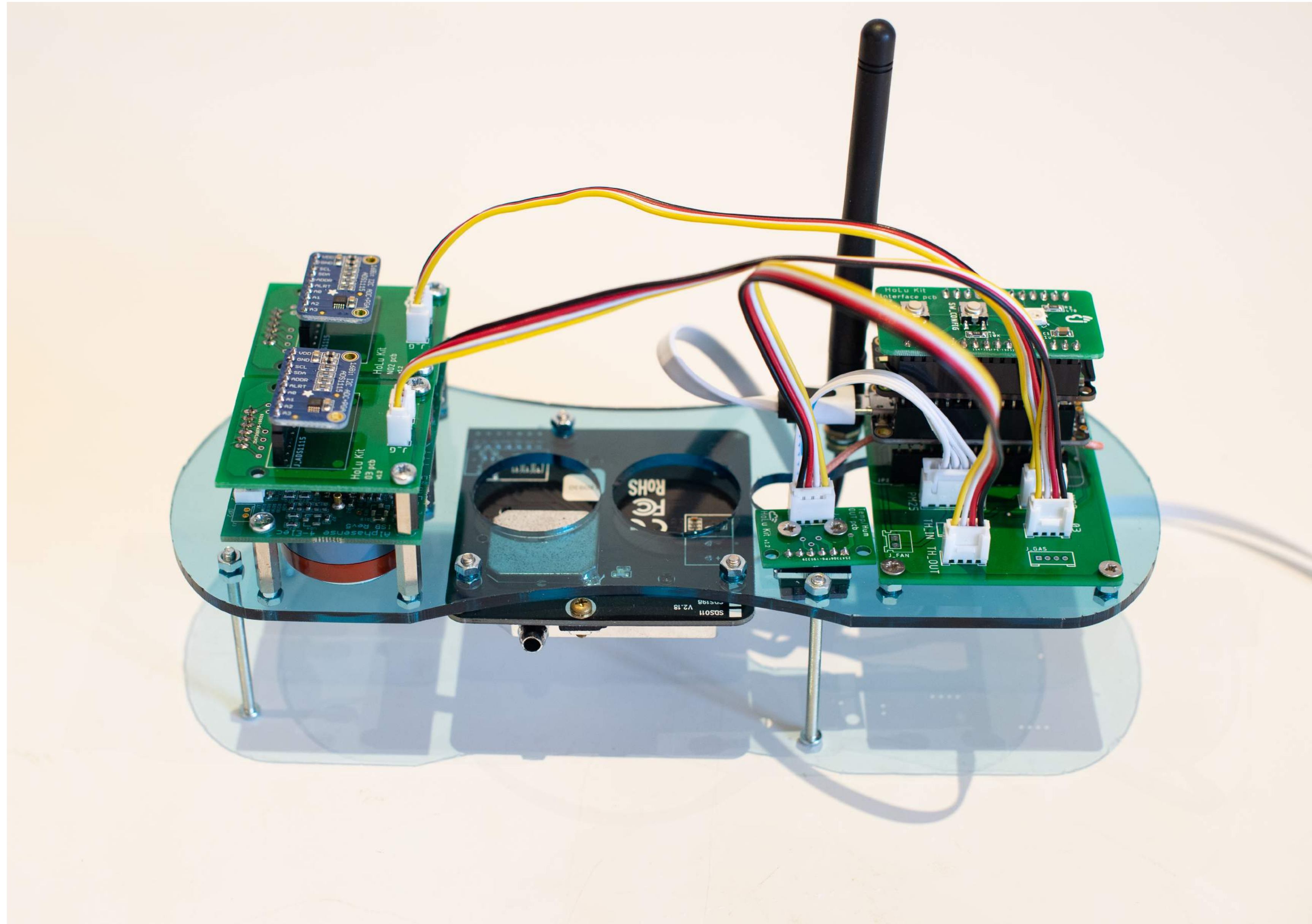

- PM2.5
- NO2
- O3
- Luchtvochtigheid
- Temperatuur

Sensing

- Laat mensen zelf knutselen aan sensor
- Co creëer je technologie (experts, hackers, burgers)



Sensing

- Burgers zijn geen meetpunten maar dataverzamelaars
- Zorg voor life feedback van data
- Denk aan sensor als visueel statement



we code for smart citizens

5. Awareness

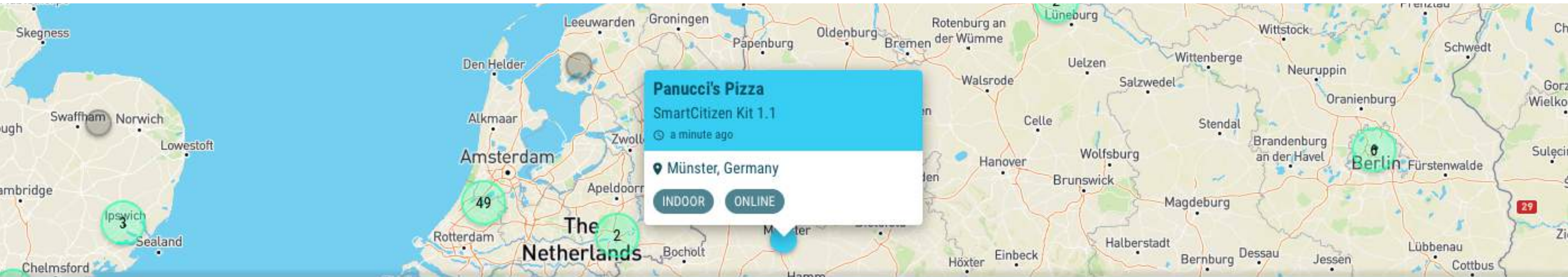

Panucci's Pizza
SmartCitizen Kit 1.1
a minute ago
Münster, Germany
INDOOR ONLINE

ifgi Panucci's Pizza 100% LAST DATA RECEIVED: JUNE 30, 2017 - 11:58

0 V pv panel 63.82 dB noise 25 # networks nets 112.20 kOhm/ppm co 200.57 kOhm/ppm no2 24.93 °C air temperature 40.00 % relative humidity

AIR TEMPERATURE

LAST DATA RECEIVED From: 23 June, 2017 To: 30 June, 2017

24.93 °C

air temperature
Air temperature is a measure of how hot or cold the air is. It is the most commonly measured weather parameter. Air temperature is dependent





Awareness

- Betrek beleidsmakers vanaf het begin
- Ziet het hele traject als awareness, niet alleen de uitkomsten
- Manage verwachtingen over uitkomsten
- Burgers kunnen nieuw gesprek voeren over probleem (data)

we code for smart citizens

6. Action





Action

- Betrek experts/beleidsmakers in duiding & actie
- Nieuwe vragen, nieuwe antwoorden
- Reserveer tijd in je planning voor nadenken actie
- Ondersteun deelnemers in actie

we code for smart citizens

7. Reflect





Reflect

- Duidt data samen met burgers
- Zet meetvragen burgers centraal bij reflectie en duiding
- Reflecteer op doelstellingen van beging

we code for smart citizens

8. Legacy



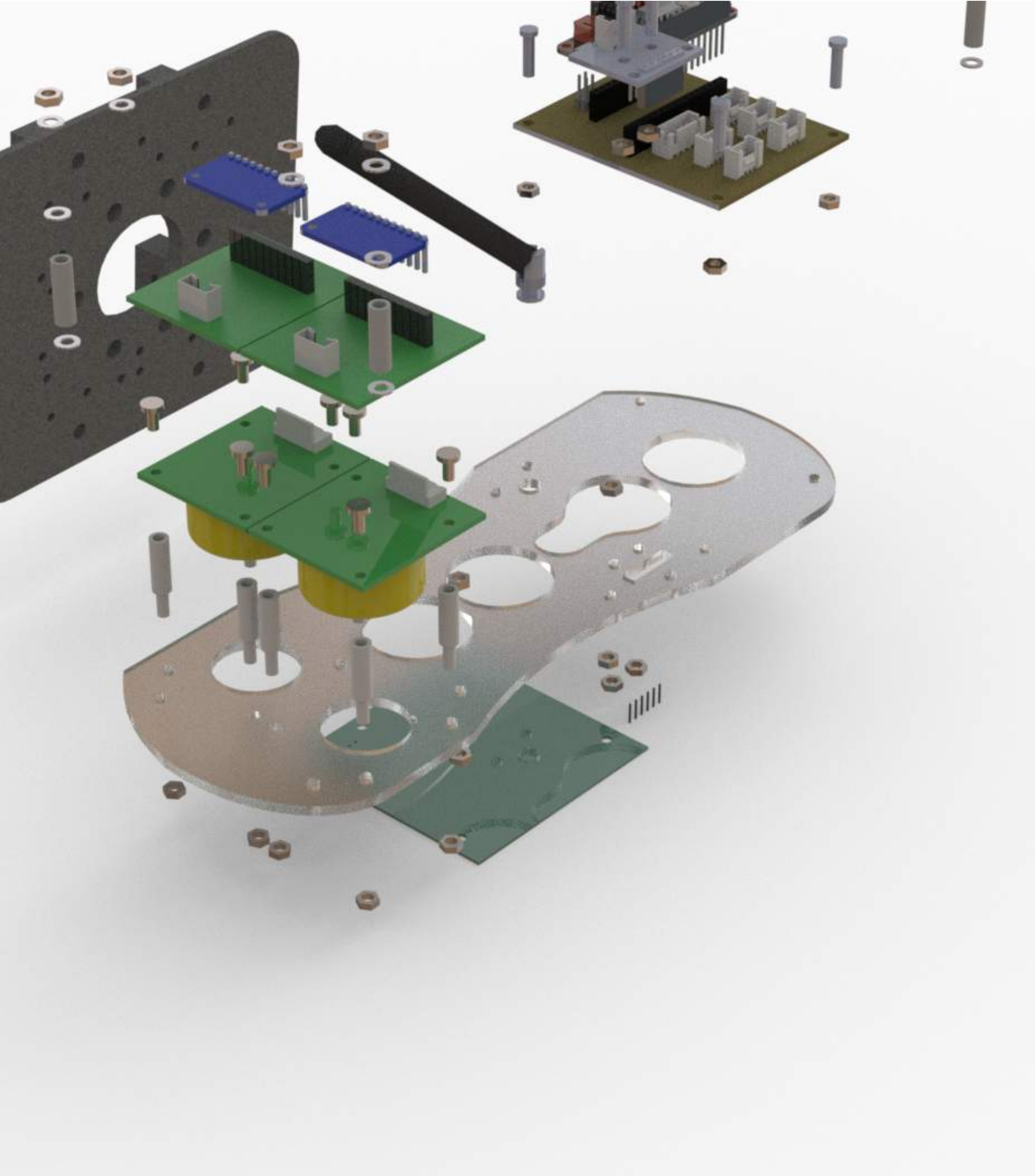

Legacy

- Documenteer je proces
- Creëer open data
- Creëer/gebruik open-source technologie
- Gebruik media voor vertellen van verhaal
- Draag je kennis over, zodat community na het project door kan

co-creation navigator
ccn.waag.org

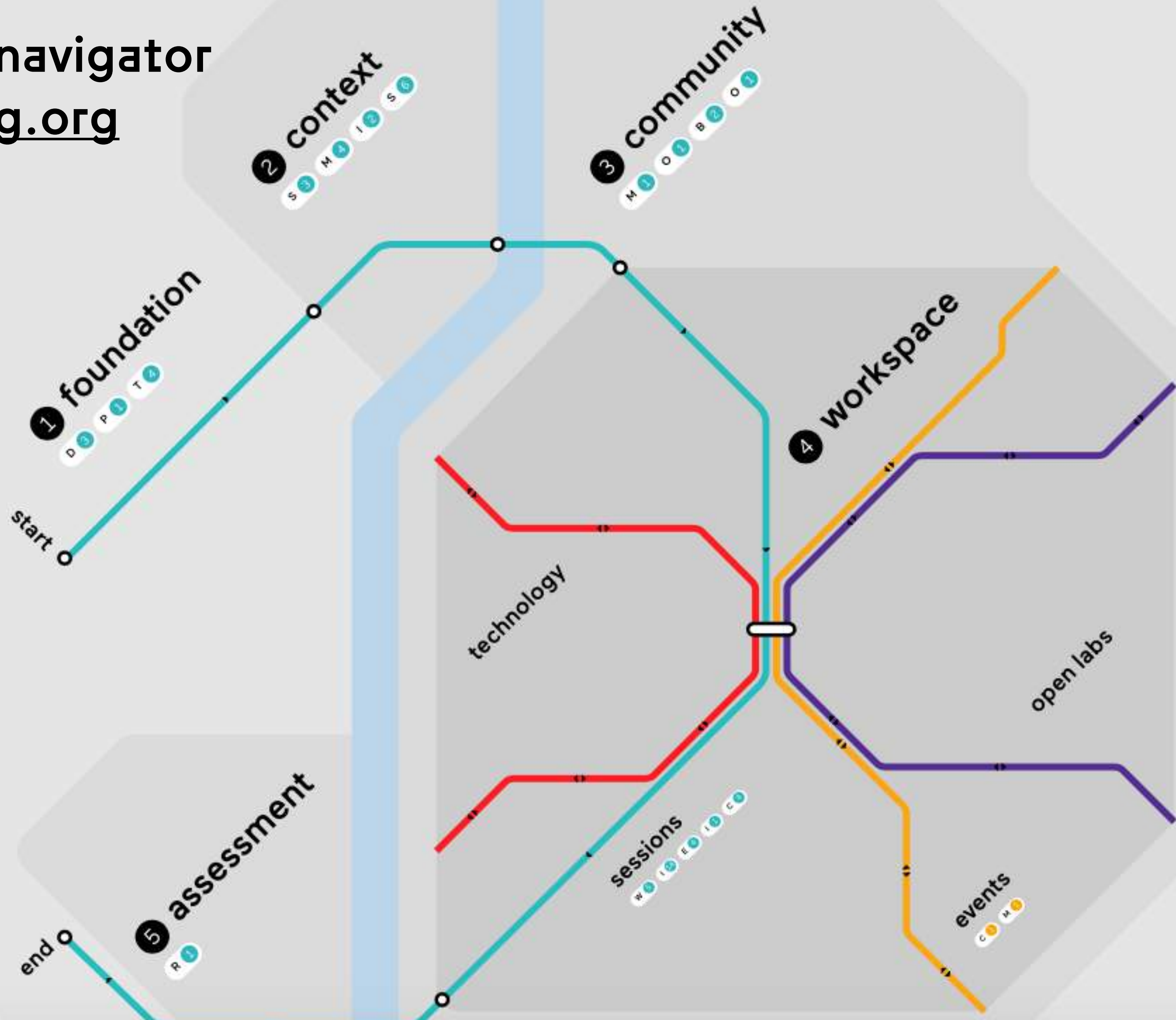

we code for smart citizens

Meer weten & op de hoogte blijven?



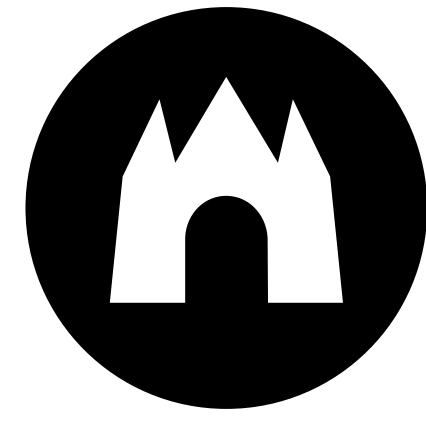

waag
technology & society

Nieuwsbrief: waag.org/nieuwsbrief

Documentaire: vimeo.com/waagmakers/citizenscience

Toolkit: waag.org -> Citizens Sensing Toolkit

Citizens Sensing Toolkit

Citizens Science Vlaanderen

Gijs Boerwinkel - gijs@waag.org
